



Features

- Small Size Standard 16 Pin SOIC or DIP Package
- 0.01% Servo Linearity
- 5300 VAC Peak Input/Output Isolation Available
- Bandwidth $\geq 40\text{kHz}$
- Machine Insertable, Wave Solderable
- Wide Power Supply Range $\pm 18\text{V}$
- Low Supply Current

Applications

- Isolated 4-20mA Converter
- Medical Sensor Isolation
- Switching Power Supply Feedback Circuits
- Isolated Temperature/Pressure Sensors
- Data Acquisition Equipment
- Isolated Motor Controls

Description

The LIA100 and LIA101 are linear isolation amplifiers that integrate a linear optocoupler with two op amps in a single package. They are available in a 16 Pin SOIC or DIP package.

Approvals

- UL Recognized: File Number E76270
- CSA Certified: File Number LR 43639-10
- BSI Certified to:
 - BS EN 60950:1992 (BS7002:1992)
Certificate #: 7344
 - BS EN 41003:1993
Certificate #: 7344

Ordering Information

| Part # | Description |
|-----------|-----------------------------|
| LIA101 | 16 Pin DIP (50/Tube) |
| LIA101P | 16 Pin Flatpack (50/Tube) |
| LIA101PTR | 16 Pin Flatpack (1000/Reel) |

Pin Configuration

LIA100/LIA101 Pinout

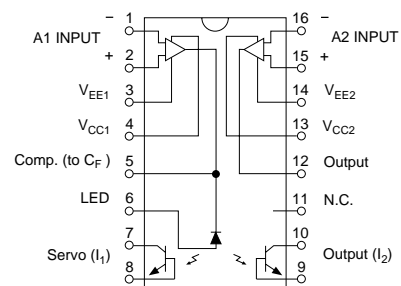

Absolute Maximum Ratings (@ 25° C)

| Parameter | Min | Typ | Max | Units |
|--|------------|-----|------|------------------|
| Supply Voltages | ± 5 | - | ±18 | V |
| Differential Input Voltage | - | - | ± 30 | V |
| Output Short Circuit Duration | Continuous | | - | |
| Total Package Dissipation | - | - | 11 | W |
| Isolation Voltage Input to Output | 3750 | - | - | V _{RMS} |
| Operational Temperature | -40 | - | +85 | °C |
| Storage Temperature | -40 | - | +125 | °C |
| Soldering Temperature DIP Package | - | - | +260 | °C |
| Surface Mount Package (10 Seconds Max.) | - | - | +220 | °C |

¹ Above 25°C Derate Linearly 1.67mW/°C

Absolute Maximum Ratings are stress ratings. Stresses in excess of these ratings can cause permanent damage to the device. Functional operation of the device at these or any other conditions beyond those indicated in the operational sections of this data sheet is not implied. Exposure of the device to the absolute maximum ratings for an extended period may degrade the device and effect its reliability.

Electrical Characteristics @ TA = +25°C and ±VCC = 15VDC (unless otherwise specified)

| PARAMETERS | CONDITIONS | MIN | TYP | MAX | UNITS |
|---|--|-----|-----------------------|------|-------------------|
| Isolation | | | | | |
| Continuous Voltage, AC | - | - | - | 3750 | V _{RMS} |
| Input to Output Leakage Current | 1000V _{RMS} , 60Hz | - | 0.2 | - | μA _{RMS} |
| Offset Voltage | | | | | |
| Output Offset Voltage (VOS) | R _F =R _{IN} =51KΩ, K3=1.000 Input Grounded T _A =25°C | - | 50 | - | mV |
| Amplifier Input Impedance | - | - | 10 ¹² 3 | - | Ω pF |
| ΔVOS/ΔT Average TC of Input Offset Voltage | R _S =50Ω | - | 5 | - | μV/°C |
| (Input and Output Stage) | | | | | |
| Common Mode Rejection Ratio, CMRR | 60Hz, R _F =1MΩ R _{IN} =10KΩ, Gain=100 | - | 100 | - | dB |
| Input Offset Voltage | R _S =50Ω, T _A =25°C | - | 3 | 10 | mV |
| Common Mode Range | | ±12 | - | - | V |
| Frequency Response | | | | | |
| Bandwidth | - | - | 40 | - | kHz |
| Slew Rate | 0-10V Step Input | - | 0.3 | - | V/μs |
| Non-Linearity | | | | | |
| | F ₀ =300Hz, -10dBm | - | - | 0.01 | % |
| Power Supplies | | | | | |
| Input Stage Supply Voltage VCC1, VEE1 | - | ±5 | - | ±18 | V |
| Output Stage Supply Voltage VCC2, VEE2 | - | ±5 | - | ±18 | V |
| Input (A1) & Output Stage (A2) Supply Current | - | - | 5 | 10 | mA |
| Power Supply Rejection Ratio, PSRR | - | - | 80 | 100 | dB |

**Electrical Characteristics @ TA = +25°C and
±VCC = 15VDC (unless otherwise specified) (Continued)**

| PARAMETERS | CONDITIONS | MIN | TYP | MAX | UNITS |
|--------------------------------|------------------------|-------|-------|-------|-------|
| LED Parameters | | | | | |
| Forward LED Current (IF) | - | - | - | 20 | mA |
| LED Forward Voltage Drop (VF) | IF=10mA | 0.9 | 1.2 | 1.4 | V |
| Reverse LED Current | VR=5V | - | - | 10 | µA |
| Reverse LED Voltage | - | - | - | 5 | V |
| Coupled Characteristics | | | | | |
| K1, Servo Gain (I1/IF) | IF=2-10mA, VCC=15V | 0.004 | 0.008 | 0.030 | |
| K2, Forward Gain (I2/IF) | IF=2-10mA, VCC=15V | 0.004 | 0.008 | 0.030 | |
| K3, Transfer Gain (K2/K1) | IF=2-10mA, VCC=15V | 0.733 | 1.000 | 1.072 | |
| K3, Temperature Coefficient | Over Temperature Range | - | 0.005 | - | %/°C |
| Temperature Range | | | | | |
| Operating | - | -40 | - | +85 | °C |
| Storage | - | -40 | - | +125 | °C |

K3 Sorted Bins

| | |
|-------|---------------|
| Bin A | = 0.550-0.605 |
| Bin B | = 0.606-0.667 |
| Bin C | = 0.668-0.732 |
| Bin D | = 0.733-0.805 |
| Bin E | = 0.806-0.886 |
| Bin F | = 0.887-0.974 |
| Bin G | = 0.975-1.072 |
| Bin H | = 1.073-1.179 |
| Bin I | = 1.180-1.297 |
| Bin J | = 1.298-1.426 |

- The LIA101 Series (through hole) is shipped in anti-static tubes of 25 pieces. The LIA100P Series (flatpack) is shipped in anti-static tubes of 50 pieces. Each tube will contain one K3 sorted bin.
- Bin designation marked on each device (A-J).
- Orders for the LIA100/LIA100P product will be shipped using bins available at the date of the order. Any bin (A-J) can be shipped.
- For customers requiring selected bins D E F G we offer part numbers LIA101/LIA101P.

PERFORMANCE DATA*

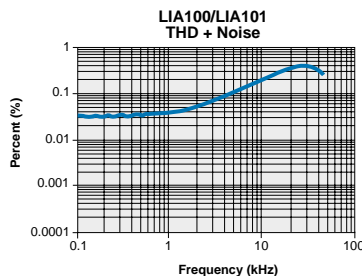
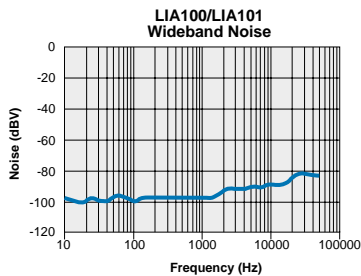
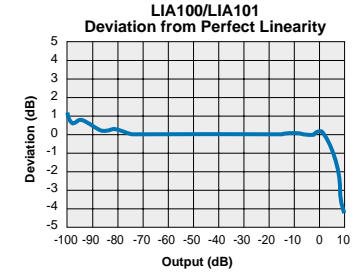
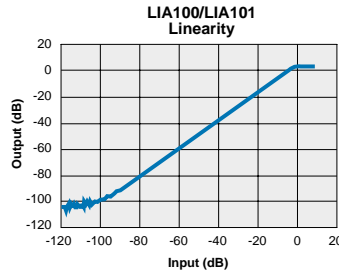
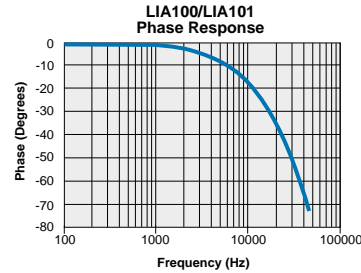
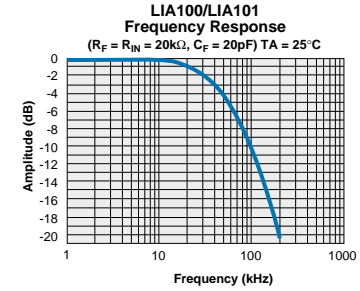
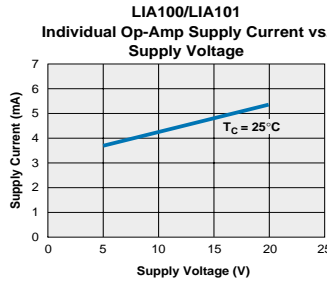
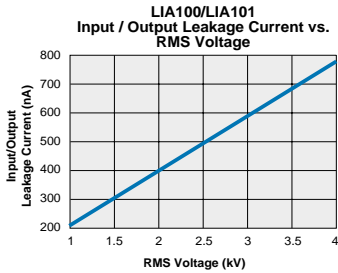
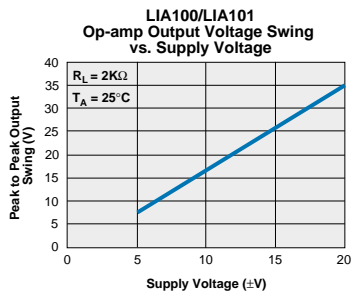
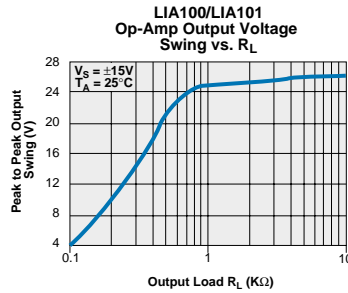
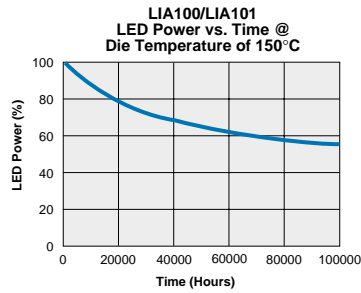
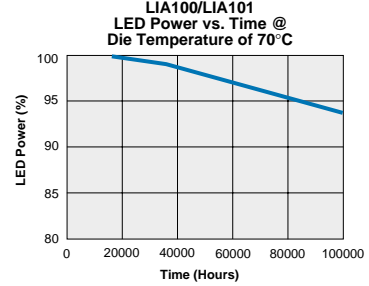
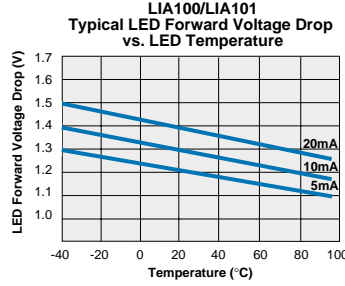
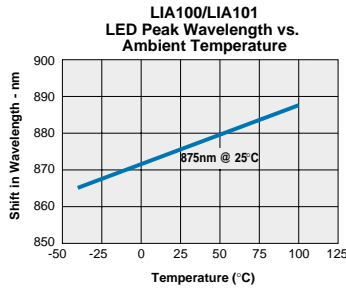

The Performance data shown in the graphs above is typical of device performance. For guaranteed parameters not indicated in the written specifications, please contact our application department.

Mechanical Dimensions

16 Pin DIP Through Hole (Standard)

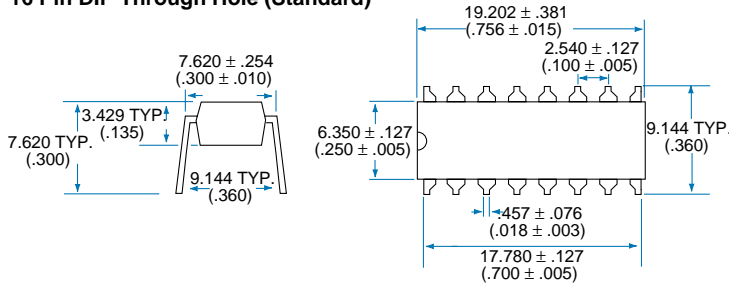

PC Board Pattern (Top View)

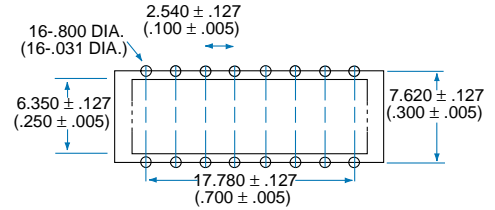

16 Pin SOIC ("P" Suffix)

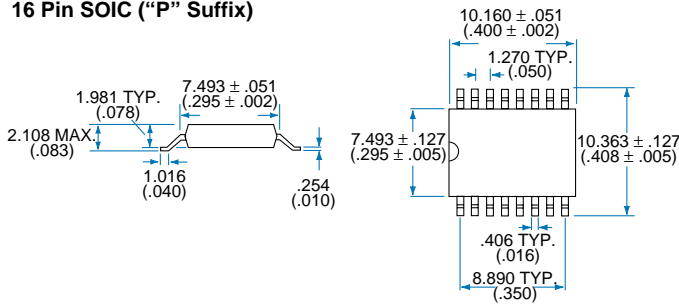

PC Board Pattern (Top View)

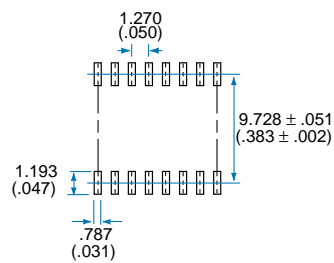

Tape and Reel Packaging for 16 Pin SOIC Package

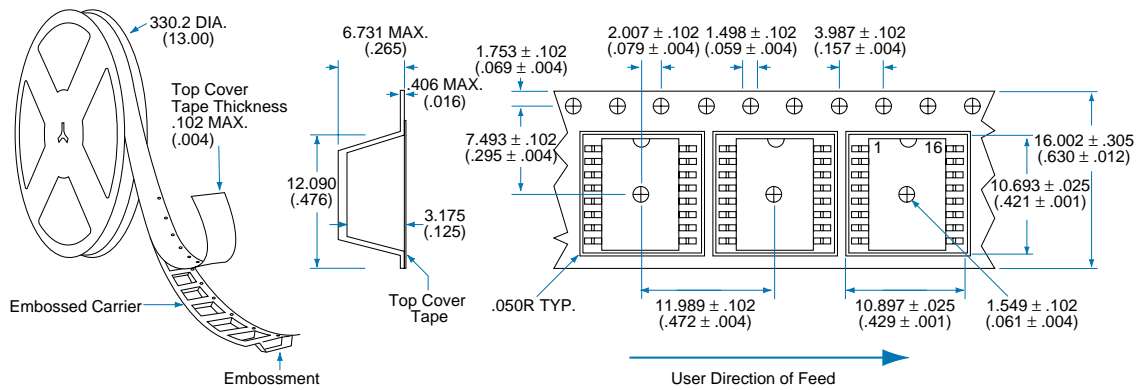

Dimensions
 mm
 (inches)



CLARE

For additional information please visit our website at: www.clare.com

Clare, Inc. makes no representations or warranties with respect to the accuracy or completeness of the contents of this publication and reserves the right to make changes to specifications and product descriptions at any time without notice. Neither circuit patent licenses nor indemnity are expressed or implied. Except as set forth in Clare's Standard Terms and Conditions of Sale, Clare, Inc. assumes no liability whatsoever, and disclaims any express or implied warranty, relating to its products including, but not limited to, the implied warranty of merchantability, fitness for a particular purpose, or infringement of any intellectual property right.

The products described in this document are not designed, intended, authorized or warranted for use as components in systems intended for surgical implant into the body, or in other applications intended to support or sustain life, or where malfunction of Clare's product may result in direct physical harm, injury, or death to a person or severe property or environmental damage. Clare, Inc. reserves the right to discontinue or make changes to its products at any time without notice.

Specification: DS-LIA101-RX
©Copyright 2002, Clare, Inc.
All rights reserved. Printed in USA.
6/25/02